



**Product Code**

**VP31053**



**63A 3P+N+E Industrial Plug IP67**

★ Rated current: 63A
★ Rated voltage: 220-380V/240-415V
★ No. of poles:3P+N+E
★ Protection degree: IP67
★ Housing material: Flame Retardant PA6 RoHS Reach Contact: nickel-plated brass RoHS Reach
★ Standards: IEC60309-1, IEC60309-2
★ Certificates: S,CB,CE,TUV,ISO9001:2008,RoHS,REACH

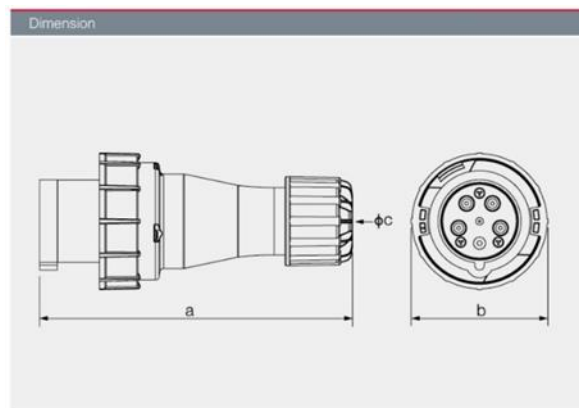

Current	63A			125A		
Pole	3	4	5	3	4	5
a	260	260	260	301	301	301
b	113.5	113.5	113.5	126	126	126
c	32	32	32	45	45	45
Cable size(mm <sup>2</sup> )	6-16			16-50		

