



Product Code

VP30059



125A 2P+E Industrial Plug IP67

★ Rated current: 125A
★ Rated voltage: 220-250V
★ No. of poles: 2P+E
★ Protection degree: IP67
★ Housing material: Flame Retardant PA6 RoHS Reach Contact: nickel-plated brass RoHS Reach
★ Standards: IEC60309-1, IEC60309-2
★ Certificates: S,CB,CE,TUV,ISO9001:2008,RoHS,REACH

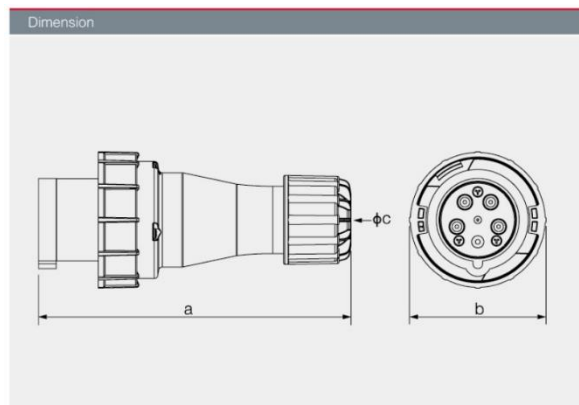

Current	63A			125A		
Pole	3	4	5	3	4	5
a	260	260	260	301	301	301
b	113.5	113.5	113.5	126	126	126
c	32	32	32	45	45	45
Cable size(mm ²)	6-16			16-50		

