



**Product Code**

**VP30026**



**16A 2P+E Industrial Plug IP67**

★ Rated current:16A
★ Rated voltage: 220-250V
★ No. of poles:2P+E
★ Protection degree: IP67
★ Housing material: Flame Retardant PA6 RoHS Reach Contact: nickel-plated brass RoHS Reach
★ Standards: IEC60309-1, IEC60309-2
★ Certificates: S,CB,CE,TUV,ISO9001:2008,RoHS,REACH

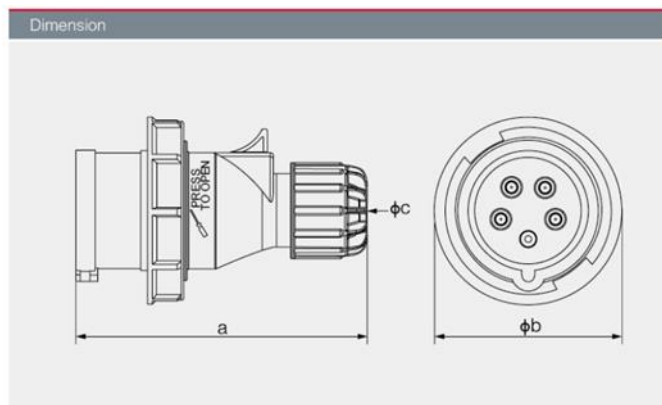

Current	16A			32A		
Pole	3	4	5	3	4	5
a	120	125	133	150	150	155
b	71	79	87	93	93	99.5
c	15	15	17	22	22	22
Cable size(mm <sup>2</sup> )	1~2.5			2.5~6		

