

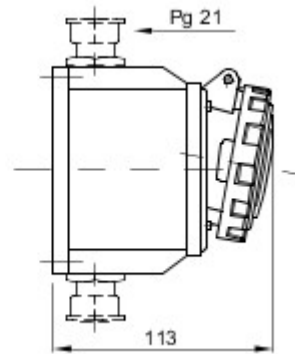

2P +E 3P+E 3P+N+E

Colour	Blue	Rated current (A)	16
IP degree	IP67	No. of poles	2P+E
Shock resistance	IK08	Reference h	6
Rated voltage	200 - 250 V	Type	10° angled surface-mounting socket-outlet
Frequency	50/60 Hz	Terminal tightening capacity	1-2.5mm ² flexible cables - 1.5-4mm ² rigid cables
Operating temperature	-25 +55 °C	Type of wiring	With screw
Electrocod	2211	Glow wire test	850 °C (active parts) - 650 °C (passive parts)
Total number of operations	> 5000	Permissible overload	22 A
Breaking capacity at 1.1 Un	20 A	Insulation resistance	> 10 MΩ
Thermo-pressure with ball	125 °C (active parts) - 80 °C (passive parts)		

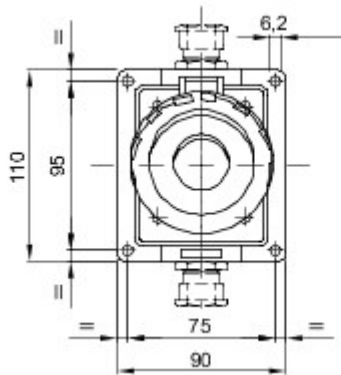

STANDARDS/APPROVALS

